

Please note: The latchbolt on these locks may be reversed without opening the case. Insert screwdriver through the back of the case, unscrew and turn latchbolt 180 degrees and retighten.

- 1** Use drilling template (see reverse) or hold the lock at the required position.

Draw horizontal lines on the door edge marking the top and bottom of the lock body.

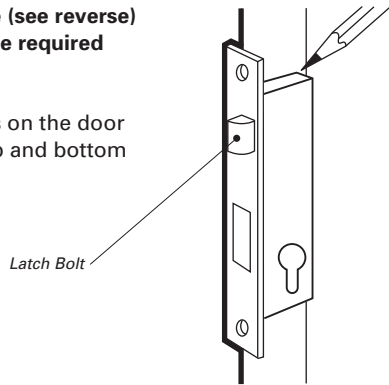

- 2** Mark a vertical line at the centre of the door edge between the two horizontal lines.

Using the attached drilling template and a 16mm bit, drill a series of holes **A** along this line to the depth of the lock body **B** or **C** or **D** or **E** depending on depth of lock body.

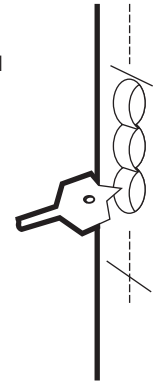

- 3** The remainder of the hole should now be chiselled out to accept the lock body.

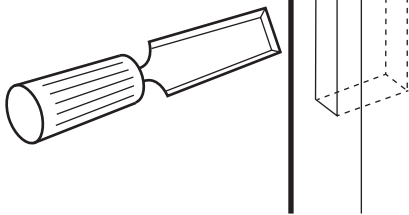

- 4** Insert the lock and mark around the forend.

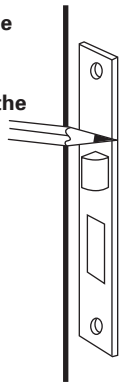

- 5** Chisel out this area to the full depth of the forend.

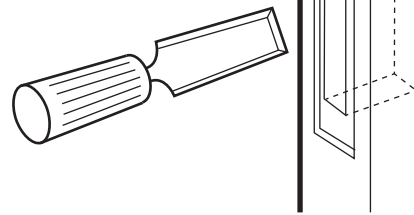

- 6** Use drilling template (see reverse) or hold the lock against the door and mark the positions for spindle and keyhole **F** or **G** or **H** or **I** depending on backset.

Prepare the hole. Fit the lock and cylinder and ensure that the bolt works correctly. Screw the lock into position.

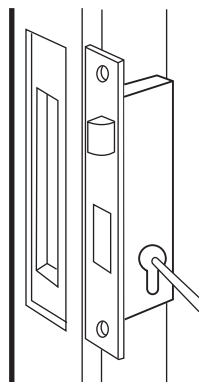

- 7** On the door frame, mark the top of the roller bolt or latchbolt and the bottom of the deadbolt.

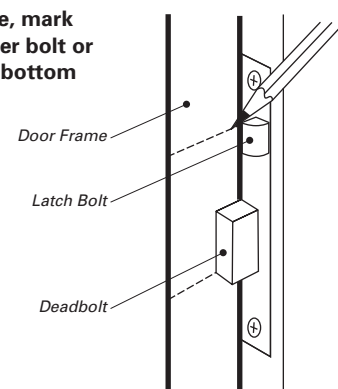

- 8** Using these guidelines check out and fit the striker plate.

Ensure tongue of striker plate is around the correct way, depending on the handing of the door.

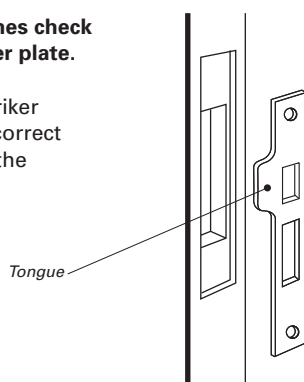

Residential Door Hardware Warranty

Sylvan residential door hardware products are covered by the following warranty.

- 10 year mechanical.
- 5 year finish (see exclusions below).

Subject to the following conditions:

If a finish or mechanical defect occurs within the warranty period, simply return the product together with proof of purchase to the point of purchase. Upon receipt of defective product it will be either repaired or replaced free of charge. This warranty only applies to the original user of the product, and is non transferable.

The Sylvan residential door hardware warranty excludes the following:

Indirect or consequential loss or damage • Cost of removal and or replacement • Cost of freight and or travel time • Improper installation or failure to follow fitting instructions • Abuse or misuse of the product • Use of the product for the purpose which the product was not designed • Scratches from keys/rings, abrasions or deterioration due to use of paint, solvents or other chemicals • Use of the product in exposed coastal or geothermal conditions • The plated finishes of Polish Brass and Black Nickel are classified as soft finishes. As deterioration is possible under some climatic conditions, these finishes are excluded from this warranty.

Position on
centre of door
or as required

Hole (A)
(16mm)
mortice

Mortice centres

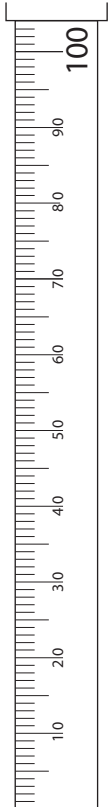

Note: If reprinting this template, ensure you print 1:1 ratio, and double check the drilling template with an accurate ruler.

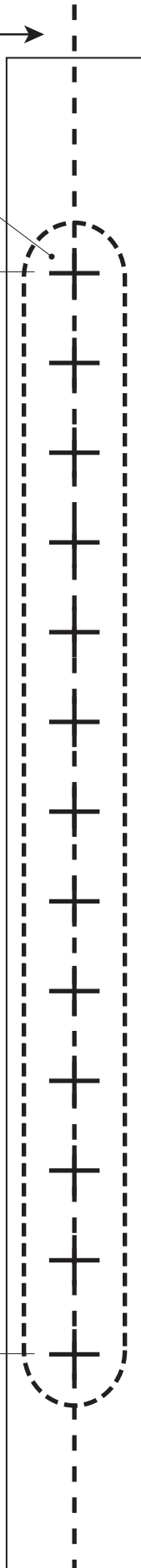

NOTE: Choose correct fold line for your lock body depth

B Lock body depth 85.5mm

C Lock body depth 75.5mm

D Lock body depth 65.5mm

E Lock body depth 60.5mm

Fold line 70mm backset

Fold line 60mm backset

Fold line 50mm backset

Fold line 45mm backset

Drill 16mm diameter hole

Drill 19mm diameter hole

85mm

F Spindle/key depth 45mm

G Spindle/key depth 50mm

H Spindle/key depth 60mm

I Spindle/key depth 70mm

Drill 12mm diameter hole